

HP.AR

HP.BCR

HP.BR

HP.CR

HP.CR3

HP.SAR

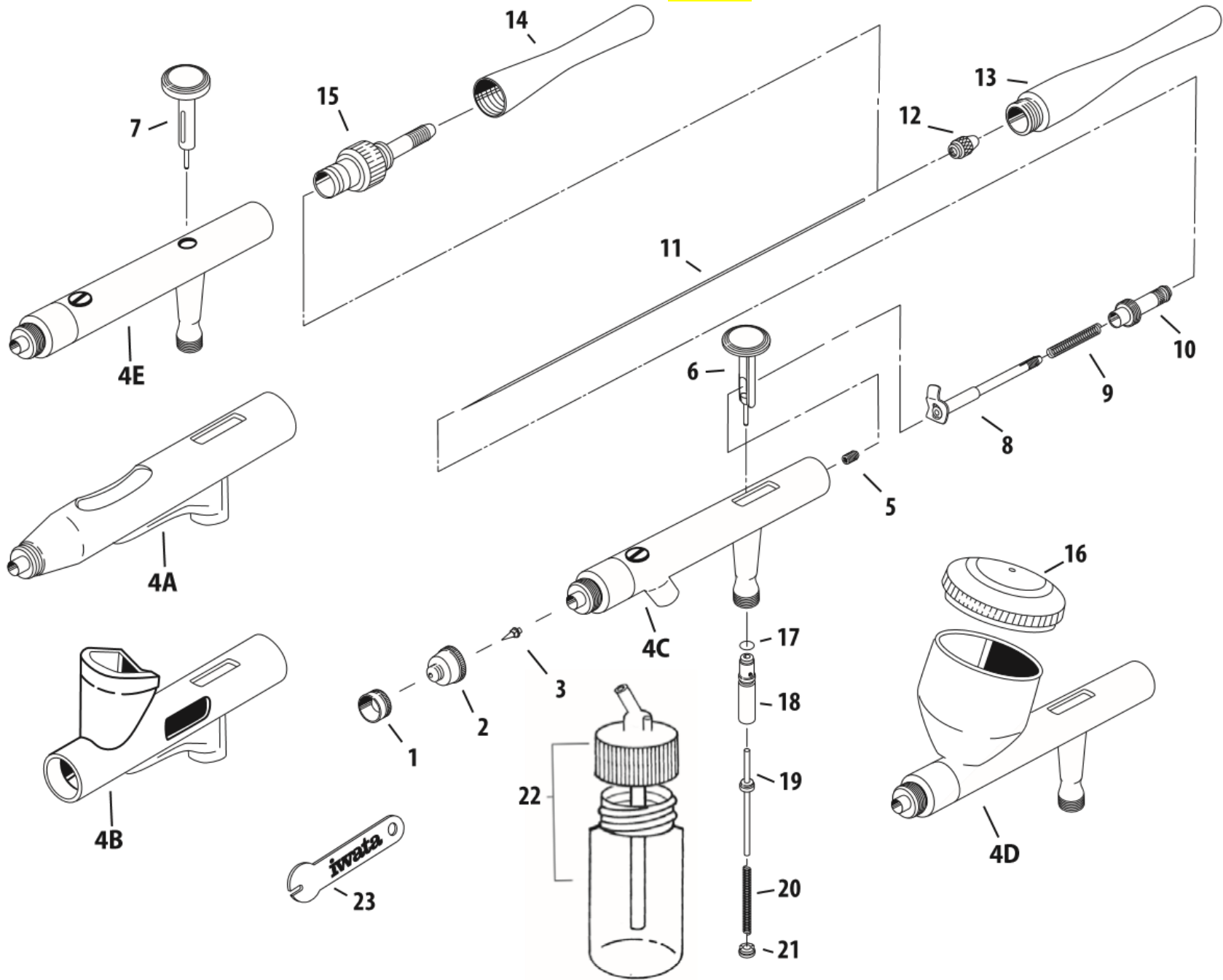

#	ITEM DESCRIPTION	ITEM #	HP-AR	HP-BR	HP-BCR	HP-CR	HP-CR3	HP-SAR
1	Needle Cap	R3 I7012	y	y	x	x	y	x
		R5 I7011	x	x	y	y	x	y
2	Nozzle Cap	R3 I7022	y	y	x	x	y	x
		R5 I7021	x	x	y	y	x	y
3	Nozzle	R3 I7042	y	y	x	x	y	x
		R5 I7041	x	x	y	y	x	y
4A	HP-AR Body*	-	y	x	x	x	x	x
4B	HP-BR Body*	-	x	y	x	x	x	x
4C	HP-BCR Body*	-	x	x	y	x	x	x
4D	HP-CR / HP-CR3 Body*	-	x	x	x	y	y	x
4E	HP-SAR Body*	-	x	x	x	x	x	y
5	Needle Packing Screw Set (PTFE)	R3 I1257	y	y	x	x	y	x
		R5 I7251	x	x	y	y	x	y
6	Main Lever	I6121	y	y	y	y	y	x

#	ITEM DESCRIPTION	ITEM #	HP-AR	HP-BR	HP-BCR	HP-CR	HP-CR3	HP-SAR
9	Needle Spring	I1351	y	y	y	y	y	x
10	Spring Guide	I7701	y	y	y	y	y	x
11	Needle	R5 I6171	x	x	y	y	x	y
		R3 I7173	y	y	x	x	y	x
12	Needle Chucking Nut	I1202	y	y	y	y	y	y
13	Ergonomic Handle	I7191	y	y	y	y	y	x
	Preset Handle	I1552	OPT	OPT	OPT	OPT	OPT	x
	Preset Cutaway Handle	I1556	OPT	OPT	OPT	OPT	OPT	x
14	Ergonomic Handle	I7192	x	x	x	x	x	y
15	Fluid Adjustment Knob	I7221	x	x	x	x	x	y
16	Lid	I6181	x	x	x	y	y	x
17	Air Valve O-ring	I5801	y	y	y	y	y	y
18	Valve Guide Body	I6081	y	y	y	y	y	y
19	Air Valve	I6091	y	y	y	y	y	y
20	Air Valve Spring	I5104	y	y	y	y	y	y
21	Air Valve Guide Screw	I6111	y	y	y	y	y	y

7	Main Lever	I6122	x	x	x	x	x	y
8	Needle Chucking Guide w/Aux Lever	I1157	y	y	x	x	x	x
		I7151	-	-	y	y	y	x

22	Bottle 1 oz / 30 ml	A4701	x	x	y	x	x	y
23	Spanner	N1651	y	y	y	y	y	y
<p>y = yes x = no OPT = Optional</p>								